



Tunable Semiconductor Laser with Continuous Tuning in 880-1010 nm Spectral Range

Date: 09-11-2015



Table of Contents

	Page
1. Introduction	3
2. The Superlum's Series of the Broadsweepers	3
3. Quasi-Collinear AOTF for Swept Source Applications	6
4. Advances in the Broadsweeper Development.....	10
5. A New Broadsweeper BS-930-1-HP with 130-nm Tuning Range	11
6. Summary	16
References	17



1. Introduction

The last decade have shown the rapidly growing development of wavelength-tunable lasers applicable for Swept Source Optical Coherence Tomography (SS-OCT) [1]. The most comprehensive review of commercially available tunable lasers for SS-OCT applications can be found in Drexler et al. [2]. A spectral tuning band of commercial swept lasers varies from 30 nm to 220 nm; a sweep rate ranges from a few kHz to hundreds MHz; an average output power can reach 50 mW. With few exceptions, most of the available wavelength-swept sources operate in the telecommunication IR band that traditionally spans 1100 – 1600 nm. The range of wavelengths from 700 nm to 1100 nm, which is now in a great demand for OCT applications, still remains mostly uncovered with commercial devices. The conventional SS-OCT technique requires a combination of lateral scanning components with a simultaneous laser frequency tuning. Therefore, SS-OCT applications, as a rule, need high sweep repetition rates exceeding 100 kHz for high quality image acquisition [2]. However, the continuous development of the CCD camera technology and data processing methods as well as an appearing of alternative imaging methods such as Full Field Swept Source OCT (FFSS-OCT) and holoscopy (that is a combination of holography and Fourier-domain full-field OCT) have made it possible to lower sweep rates [3, 4, 5]. By using these methods, an entire imaging area can be illuminated and processed at the same time. With the FFSS-OCT, an entire tomogram can be acquired in a single sweep, which makes this method less restrictive to frequency sweeping speeds [3]. In comparison to the conventional SS-OCT systems, full-field ones require lower values of light exposition on a sample surface at each frequency. Because all spots on a sample are illuminated simultaneously during image acquisition, the total power of a full-field OCT system can be much higher than in case of an SS-OCT system, without any risk to damage the sample. This fact results in an increased sensitivity for imaging.

Despite the fact that the primary driving force of the OCT technique is medical and biological applications, other OCT-based applications requiring swept sources with high sweep rates, narrow spectral linewidths, high power of laser emission and wide tuning bands are rapidly emerging. They include non-destructive testing (NDT) and engineering applications [6, 7]. Moreover, they are of practical interest for industrial OCT applications, among which the most important are characterization of multi-layered foils, study of artwork; micro-structural analysis in plant and food sciences; characterization of tablet coatings and structural changes in materials [8]. Other practical uses of wavelength-tunable lasers are being rapidly developed.

2. The Superlum's Series of the Broadsweepers

The first tunable laser from Superlum was created in 2006 [9, 10]. It was the result of our two years investigation in building tunable semiconductor lasers intended for a wide variety of applications in research labs and production areas (**Fig. 1, a**). This laser was the BS-840-1 model that was capable to tune the wavelength of emission over 50-nm spectral range with a center wavelength around 845 nm at a sweep speed from 10 nm/s to 10000 nm/s. The laser was relied on a linear external cavity that was a combination of a gain-module (SOA-371) serving as a gain medium and a quasi-collinear acousto-optic tunable filter (AOTF), which functioned as a wavelength-selective intracavity element. The filter had a unique design that



featured a very high spectral resolution – 0.2 nm at 850 nm. The diffraction efficiency of the filter reached 90% in the range 800-900 nm. The first model suffered from one crucial drawback – the wavelength of emission was significantly dependent on the environmental temperature. This effect was related to the temperature dependence of the filter. Early versions of the AOTF assembly did not ensure high spectral stability of the filter spectral width because they were not equipped with temperature stabilization systems (**Fig. 1, b**).



(a)



(b)

Figure 1. Left (a): Photograph of the first tunable semiconductor laser from Superlum – the Broadsweeper BS-840-1. The device was capable to sweep over a 50-nm spectral range (820 nm – 870 nm) at sweep speeds adjustable from 10 nm/s to 10000 nm/s. The laser produced 3 mW of the output power within a spectral line of 0.05 nm (FWHM). The laser was based on a linear external cavity configuration and a gain module. **Right (b):** Photograph of one of the early inline assemblies of the AOTF; it is no longer used in the Broadsweepers as this type of construction does not provide temperature stabilization control of the AOTF.

The first Superlum's tunable laser generated the maximum optical power of 3 mW and operated in constant power mode, which is also known as automatic power control (APC) mode (**Fig. 2**). The Broadsweeper used analog powering electronics both for the gain-module driving and for wavelength control of laser emission.

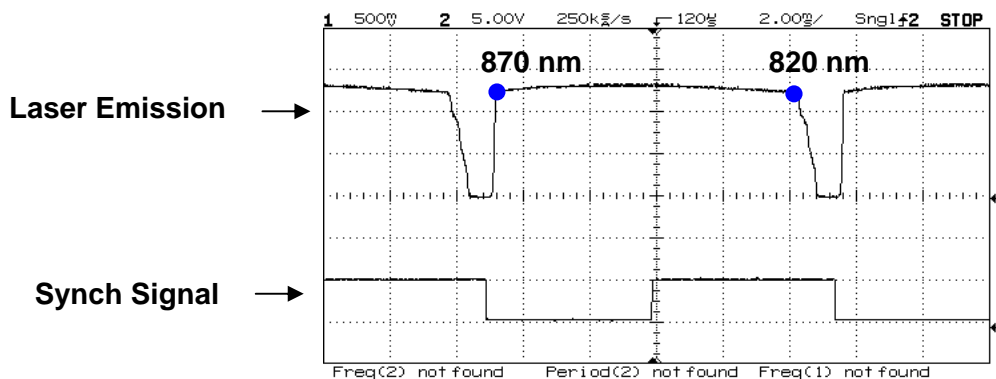

Figure 2. Oscillogram of sweep operation of the first tunable semiconductor laser – the Broadsweeper BS-840-1. The laser operated in the constant power mode. Nonflatness of the top of the upper curve (Laser Emission) is related to differences between spectral characteristics of a photodiode operated in the APC system of the Broadsweeper and of a photodiode used for detecting the optical power at the laser output.

Since those days, the family of Superlum's tunable lasers has been considerably expanded; the construction of the lasers has been re-designed; their technical characteristics have been greatly improved. Now, the line of this product covers a wide range of wavelengths, from 750 nm to 1100 nm (see **Table 1**). It is the range where very few models of rapidly swept lasers from other manufactures are commercially available.

Each standard model of the BROADSWEEPER is now built on the use of Superlum's semiconductor optical amplifier (SOA) and an acousto-optic tunable filter. The laser cavity is based on a PM-fiber ring configuration. The photograph of a standard model of the BROADSWEEPER BS-840-1-HP with an integrated optical power booster is shown in **Fig. 3**.

Table 1. Standard models of the BROADSWEEPER series.

Tuning range, nm	Model	Max. Sweep Speed ¹ , nm/s	Linewidth, nm
765-815	BS-785-1/2	10000 / 100000	0.06 / 0.12
805-880	BS-840-1/2	10000 / 100000	0.06 / 0.12
900-980	BS-930-1/2	10000 / 100000	0.09 / 0.15
1020-1090	BS-1060-1/2	10000 / 100000	0.09 / 0.15

¹ the BROADSWEEPER is offered in Slow Sweep Speed and Fast Sweep Speed variants.

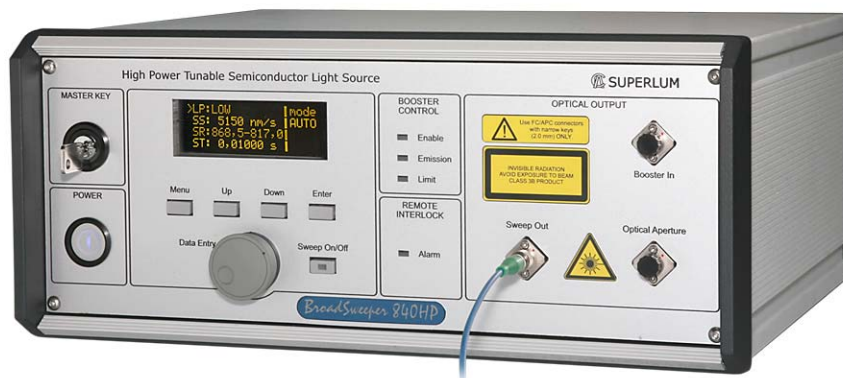

Figure 3. Photograph of the BROADSWEEPER BS-840-1-HP high power tunable semiconductor laser offered as a standard model. The model combines a wavelength-swept source and an optical power booster. The device provides sweep operation over a 75-nm spectral range at sweep speeds from 2 nm/s to 10000 nm/s and the output power of 3 mW from the swept source output (Sweep Out) that can be amplified to 20 mW by the booster (Optical Aperture). The optical connection between the swept laser and the booster is accomplished externally with an optical patch cord (supplied with the instrument). For more technical information on the product, go to our website: www.superlumdiodes.com

All standard models of the Broadsweeper allow operation in the following modes:

- **Manual Sweep mode:** Provides CW operation at any wavelength within the full tuning range. The user can tune the emission wavelength within the full wavelength range with a 50-pm resolution.
- **Automatic/External Sweep mode:** Provides continuous sweeps repetitive in time over the full tuning range or over a band of interest within the full tuning range. Minimum sweep interval is 5 nm. In the External Sweep mode, the device enables sweep operation with user-defined settings when external trigger signals are applied.
- **Modulation Sweep mode:** Provides continuous wavelength switching between two user-defined settings within the full tuning range at a certain repetition frequency. The range of frequencies includes 13 factory-set values.

Depending on the model type of the Broadsweepers, the linewidth of laser emission varies from 0.06 nm to 0.15 nm. The SS-OCT imaging depth directly depends on the following key factors: the wavelength tuning range, optical output power and instantaneous linewidth of laser emission. In a recent research, Shramenko M.V. et al. [11] used the Broadsweeper BS-1060-1 in an SS-OCT system with an extended imaging depth. The cross-section image of a contact lens immersed in an intra-lipid solution was obtained with an imaging depth of more than 5 mm.

3. Quasi-Collinear AOTF for Swept Source Applications

In all slow sweep speed models of the Broadsweeper (<10000 nm/s), the wavelength tuning technique utilizes a quasi-collinear AOTF that has a very narrow spectral passband ranging from 0.2 to 0.3 nm at FWHM (**Fig. 4**).

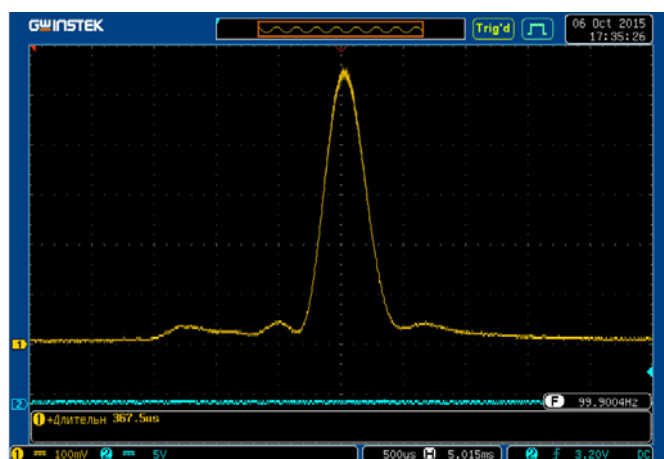

Figure 4. Transmittance function of a typical quasi-collinear AOTF. The trace was recorded by scanning the filter with a sweep rate of 100 Hz, while a 5mW-860nm diode laser was operated constantly in CW mode. The laser had a linewidth of below 0.02 nm. In terms of Hz, the measured passband of the AOTF was 27 kHz (FWHM) that corresponded to 0.24 nm.



The AOTF consists of a lithium niobate piezoelectric transducer bonded to one side of a birefringent TeO_2 crystal and a sound absorber located on the opposite side of the crystal (**Fig. 5**). When an RF control signal is applied to the transducer, it generates acoustic waves, which travel through in the crystal medium. These waves produce a periodic refractive index modulation of the TeO_2 crystal that, in other words, can be described as a moving phase grating. When the light enters the crystal, it will diffract on this induced grating providing that certain phase-matching conditions have been met. The AOTF needs horizontally polarized light at the input. The diffracted light will leave the crystal at an angle different from that of the non-diffracted light. The angle between the diffracted and non-diffracted light beams is called the separation angle. For the device in question, this angle is 1.9° . The filter demonstrates 90° rotation of the input polarization. The switching time between random wavelengths is equal to the transit time of the sound wave across the optical beam, which for the filter under consideration is approximately $40 \mu\text{s}$. It is the transit time that limits the maximum sweep speed of the BROADSWEEPER to 10000 nm/s .

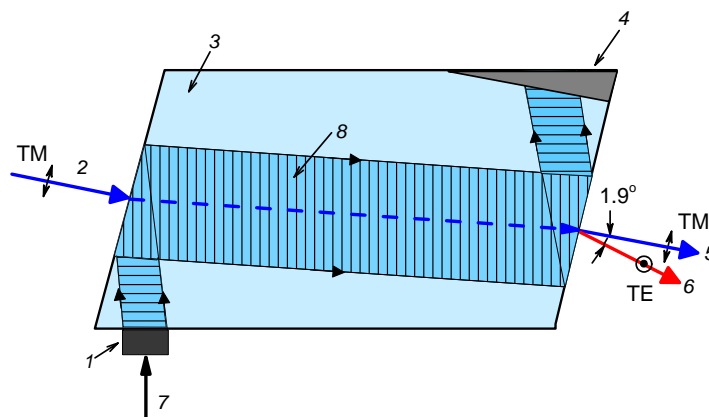

Figure 5. Schematic illustration of a quasi-collinear AOTF showing lithium niobate piezoelectric transducer **1**; horizontally-polarized input optical beam **2**, TeO_2 crystal **3**, sound absorber **4**, transmitted optical beam (the zero order) **5**, vertically-polarized diffracted optical beam (the first order) **6**, RF control signal **7**, traveling acoustic beam in the crystal **8**.

For a fixed acoustic frequency, only a narrow band of optical frequencies can be diffracted, leading to a high resolution of the AOTF [12]. Because the acoustic frequency is driven by an RF signal fed into the transducer, the filter spectral width can be precisely tuned by changing the frequency of the RF signal. Since the laser cavity contains no mechanically moving components, any chief drawbacks of optical mechanics (such as mechanical drifts in time, loose operation etc.) are eliminated; therefore, high accuracy of the wavelength selectivity and excellent wavelength reproducibility in sweep operation are ensured. In addition, the AOTF tuning characteristics provides k -linear frequency sweep over a wide range of wavelengths (**Fig. 6**).

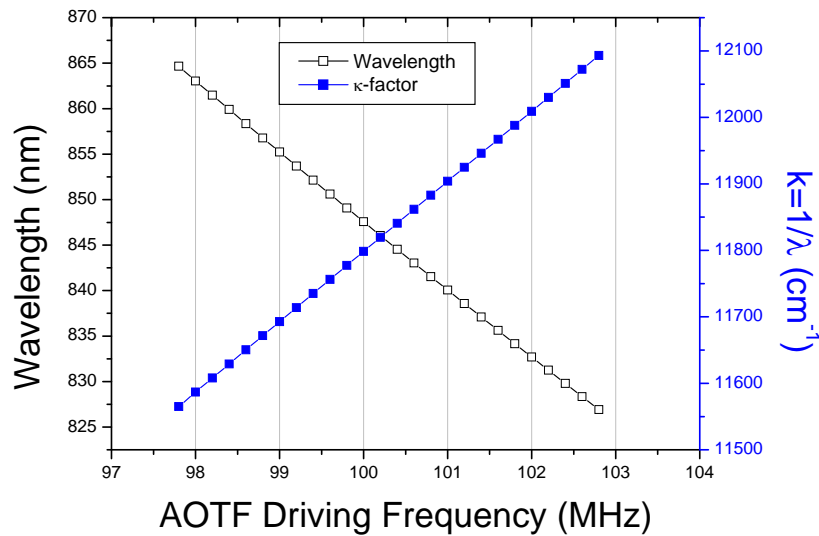

Figure 6. Typical tuning curve for a quasi-collinear filter used in the BS-840-1. The plot shows also a k -factor-frequency dependence (see the blue curve). One can see that this curve is strictly linear in a range of the drive frequencies. This fact makes the use of quasi-collinear AOTFs for wavelength tuning beneficial for various OCT applications.

It is well known that AOTFs are inherently temperature dependent devices. An AOTF shifts its spectral passband as the operating temperature changes that affects the spectral stability of the emission wavelength. For the quasi-collinear AOTF, a wavelength temperature dependence of 0.18 nm/°C has been experimentally measured. To overcome this drawback, the filter is packaged into a compact metal housing with a thermoelectric cooler and a thermistor for AOTF temperature stabilization (**Fig. 7**). This packaging is then integrated into an inline AOTF assembly that provides fiber-to-fiber transmission and active temperature control of the filter (**Fig.8**). With this control, high spectral stability of the emission wavelength in time and under different temperature conditions is guaranteed (**Fig. 9**).

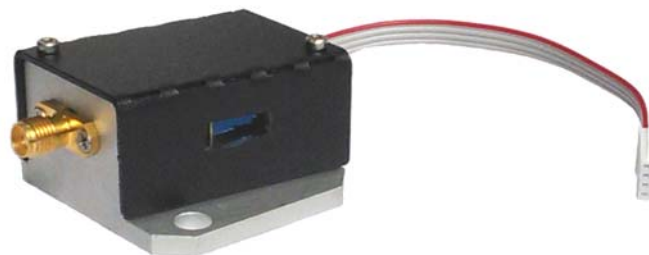

Figure 7. Photograph of a typical quasi-collinear AOTF. This unit requires 0.2 W of RF power and provides 0.2-nm spectral width at 860-nm wavelength with a diffraction efficiency of 90%. The separation angle between the first-order beam and the zero-order beam is 1.9°. The clear aperture of the filter is 5 mm. The device accepts operation with an optical beam of 1.2 mm in diameter, which is used in the Broadsweeper. The flat cable of the unit is intended for active temperature control of the filter.

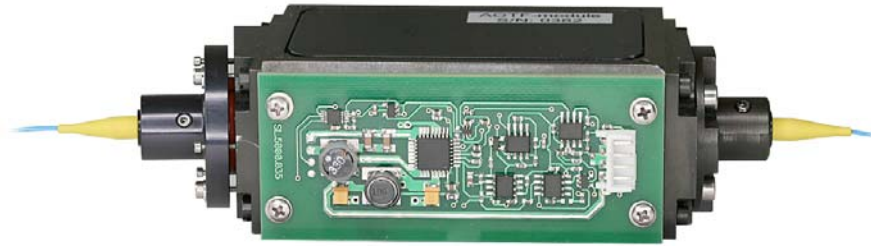

Figure 8. This photograph shows an inline AOTF assembly with a temperature controller PCB on the device side. The construction of this type is now used in all standard models of the Broadsweeper.

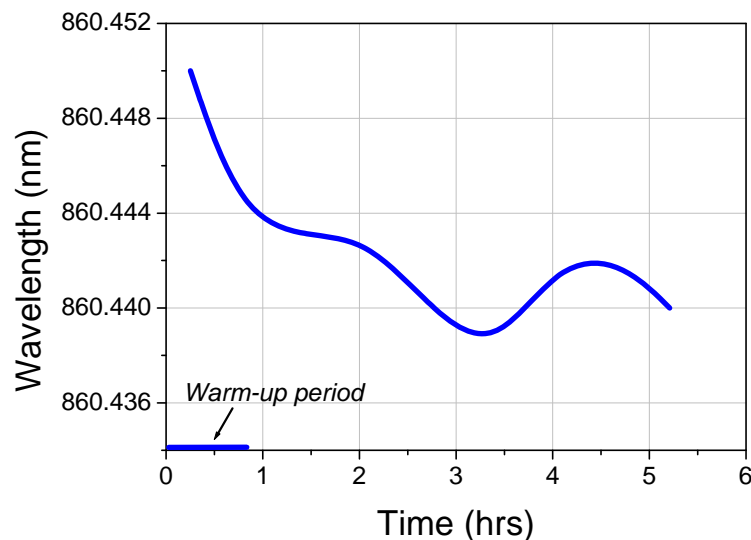

Figure 9. Spectral drift of the emission wavelength in time. The data were acquired during a wavelength stability test conducted on the Broadsweeper BS-840-1. The laser under test together with measuring equipment was located inside of a temperature chamber where the environmental temperature was held at $+22 \pm 0.1^\circ\text{C}$. It is seen that after allowing for the Broadsweeper warm up, the device shows spectral stability of the emission wavelength within 5 pm.

Quasi-collinear AOTFs for conventional spectral ranges of OCT systems are now available on the market. The chief drawback of using AOTF-based swept sources for OCT systems is that they do not provide sweep repetition rates greater than 2 kHz, which, in most cases, might be insufficient for medical and biological applications of SS-OCT. On the other hand, swept sources of this kind could be used in full-field OCT applications, which do not require high values of the sweep rate. In addition, they remain of practical interest for a number of applications, including spectroscopy, optical metrology, characterization of optical components and the other.



4. Advances in the Broadcaster Development

Until recently, the wavelength-tuning range of an individual swept source of the Broadcaster series was limited to the maximum value of 80 nm. The development of new types of traveling wave SOAs based on laser heterostructures with ultra thin active layers have made it possible to realize a tuning range of 100 nm in 750-1000 nm wavelength range (type I) and of up to 135 nm in the spectral range from 880 nm to 1015 nm (type II) [13, 14]. The SOAs had the form of symmetric separate-confinement double heterostructures (SCDHS's) grown by metal organic vapour phase epitaxy (MOVPE) process. These two types of SOAs were deliberately chosen for utilization in new broadband models of the Broadcaster. The SOA design was identical to that described in [13]. Small signal gain spectra of the SOAs promised a tuning range exceeding 100 nm (**Fig. 10**). According to the results of preliminary life tests conducted on these SOAs in double-pass amplification regime at output power of 20 mW (CW), the devices demonstrated a median lifetime of 15000 hours for type I and 50000 hours for type II, respectively. The median lifetime estimated as the time of operation after which the output power of an SOA drops by 50%. The obtained data showed high reliability of the developed structures.

The spectral bandwidth of a swept source for OCT uses is inversely proportional to the axial (or depth) resolution of an OCT imaging system. Consequently, an increase in the wavelength-tuning range of a laser makes the use of this swept source highly beneficial in OCT systems.

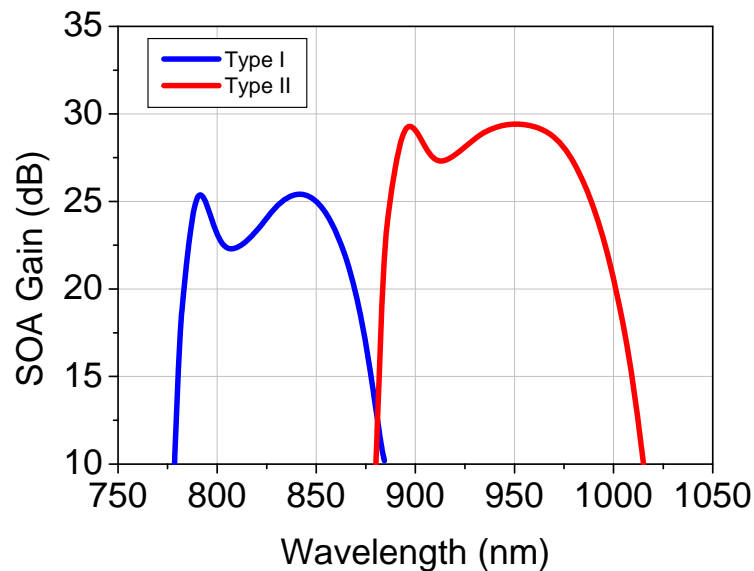

Figure 10. Small signal gain spectra of two types of SOAs. The spectra was measured at injection currents of 250 mA for type I and of 220 mA for type II.



5. A New Broadsweeper BS-930-1-HP with 130-nm Tuning Range

A fiber-coupled module based on an SOA chip of type II has been used to build a new broadband model of the Broadsweeper – BS-930-1-HP. **Fig. 11** schematically illustrates an internal construction of the Broadsweeper. As the figure shows, the device consisted of two optical units: the wavelength-swept source and the optical power booster. The first unit produced a low-power laser emission (1 mW) with a wavelength tunable over 900-1000 nm spectral range, while the second unit amplified the low power of the laser to high-power levels (15 mW). Such a combination of a master source and an optical power booster is widely used in a large variety of applications and called **Master Oscillator Power Amplifier (MOPA)**.

The wavelength-swept source was an external cavity laser that was built on a ring cavity configuration (see elements **1-7** in **Fig. 11**). The optical scheme of the laser resonator was composed of an SOA module **1**, an AOTF assembly **2** with a built-in optical isolator **3**, a fiber-optic coupler with 70/30 % splitting ratio **5**, a fiber-optic coupler with 90/10 % splitting ratio **6** and a monitor PD **7**. The fiber-pigtailed SOA module with the maximum fiber-to-fiber optical gain of 30 dB functioned as a gain medium. The inline AOTF assembly contained also a free-space optical isolator **3**. The isolator was intended to provide unidirectional light propagation in the external cavity. It featured very high transmission of about 92-95% at 930 nm and high isolation of better than 30 dB. The AOTF is a bulk optical element that requires a well-collimated optical beam to provide the best performance. To meet this requirement and to realize fiber-to-fiber light transmission, two fiber-coupled collimators with aspherical lenses were introduced into the AOTF assembly. The collimators produced perfectly circulated diffraction-limited beams of 1.2 mm in diameter and allowed fiber-to-fiber transmission efficiency of 85% to be achieved. The 70/30 % fiber coupler enabled the laser power to be divided in the necessary proportion. The 70% fiber was used as an output of the laser, while optical power in the 30% fiber was directed back into the external cavity. The 90/10% fiber coupler played the role of an optical power monitor that provided 10% power tapping for monitoring by a silicon PD of the APC system (see element **7** in **Fig. 11**).

The optical power booster consisted of a fiber-coupled isolator **8**, an SOA module **9**, a fiber-optic coupler with 95/5% splitting ratio **10** and a monitor PD **12**. The SOA module used in the booster was identical to that implemented in the swept source. It was necessary to achieve perfect spectral matching between the laser and the booster. The fiber-optic isolator blocked any SOA emission towards the output of the swept laser to exclude any influence on the laser operation. The 95/5% fiber coupler together with the monitor PD acted as an optical power monitor – they provided the necessary feedback signal for the APC system of the booster.

Most of the fiber-optic components were customized for providing the best performance suitable for broadband applications. In addition, they were built on the fast-axis-blocked technology that ensured high values of PER (Polarization Extinction Ratio) at the optical output. The fiber type implemented in the Broadsweeper was PANDA PM 980. Light polarization at the output of the Broadsweeper was oriented in the slow axis of the PM fiber. The instrument showed PER of better than 28 dB. To ensure low optical loss and high values of PER at the output of a patch



cord connected to the instrument, the device was equipped with a precision optical socket for optical connectors of FC/APC type with narrow keys (2.0 mm).

Powering electronics operated the SOA modules in the constant power mode. SOA protection concerns such as transient protection, output limit control, temperature monitoring, soft start of the drive current and the others were incorporated in the driving electronics. Since the BROADSWEEPER described here was classified as a Class 3B laser product, the laser safety measures specified in IEC 60825-1 (Edition 2.0) such as master key control, remote interlock, informational labeling etc. were realized in the instrument construction.

The full tuning range of BS-930-1-HP achieved 130 nm at the output power of 15 mW. **Fig. 12** illustrates how the emission spectrum behaves at different operating wavelengths. One can see from the figure that depending on the spectral position of the emission wavelength the SMS ratio varies between 27 dB and 45 dB. **Fig. 13** represents the effect of the wavelength tuning on the injection current of the booster SOA and on the SMS ratio value. **Fig. 14** shows a typical linewidth of the laser in CW operation recorded by using an OSA with high resolution.

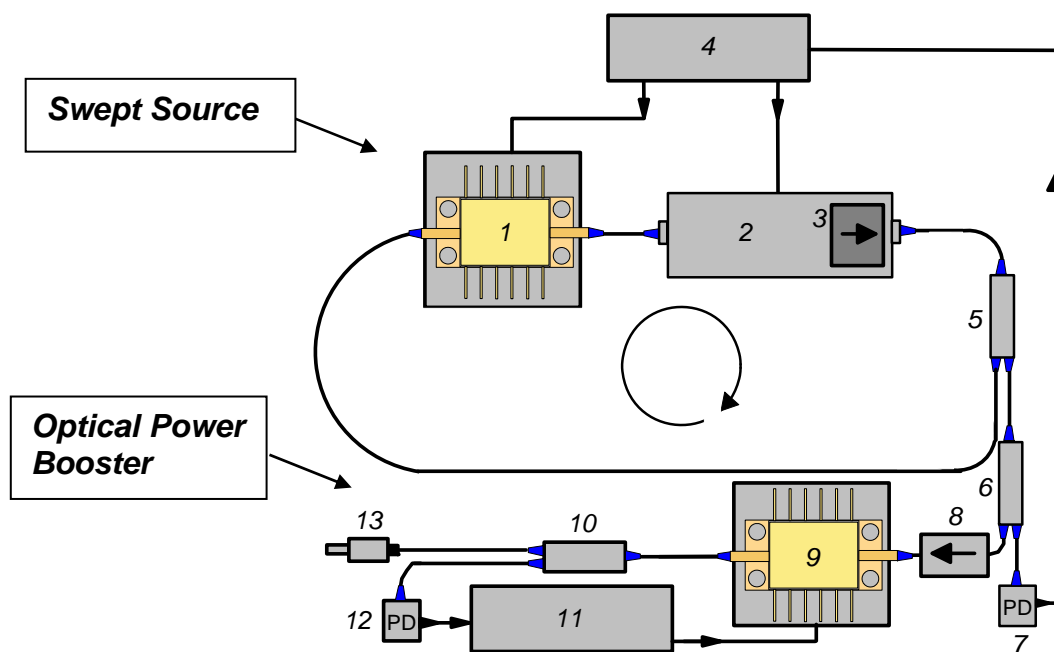

Figure 11. Schematic diagram of the optical unit configuration of the BROADSWEEPER: **1** – SOA module of the swept laser; **2** – inline AOTF assembly with two optical collimators; **3** – optical isolator; **4** – SOA driver & AOTF controller; **5** – 70/30% fiber-optic coupler; **6** – 90/10% fiber-optic coupler; **7** – monitor PD of the swept source; **8** – fiber-optic isolator; **9** – SOA module of the booster unit; **10** – 95/5% fiber-optic coupler; **11** – SOA current & temperature controller; **12** – monitor PD of the booster; **13** – FC/APC optical connector (optical output).

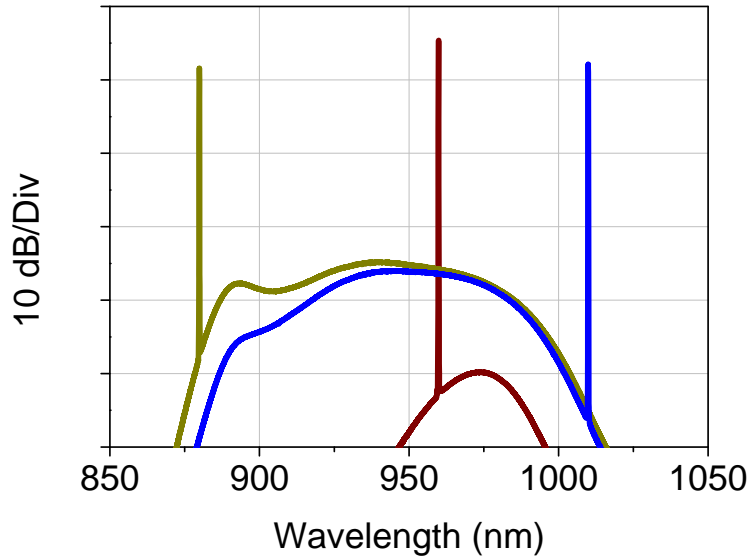

Figure 12. Emission spectra of the Broadsweeper BS-930-1-HP at different operating wavelengths. The spectra were recorded at 15 mW of output power in the Manual Sweep mode (CW operation).

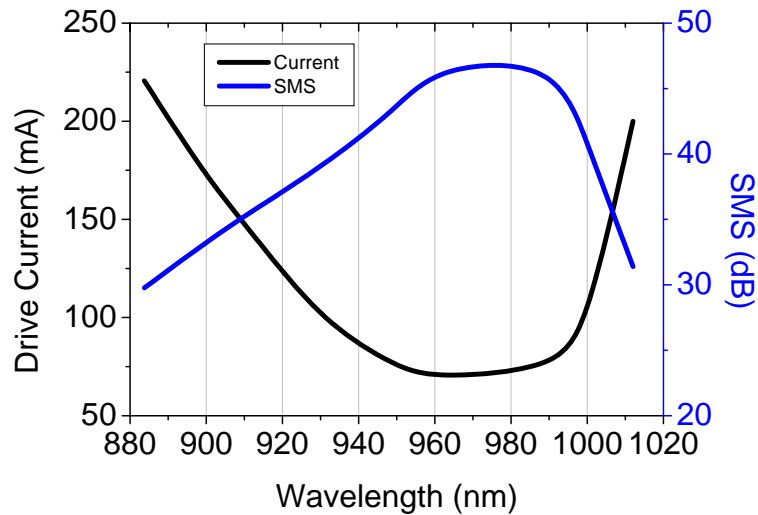

Figure 13. Wavelength tuning effect on SOA injection current (black line) and SMS ratio (blue line). The data were measured at the booster output. The booster operated in APC mode at 15 mW.

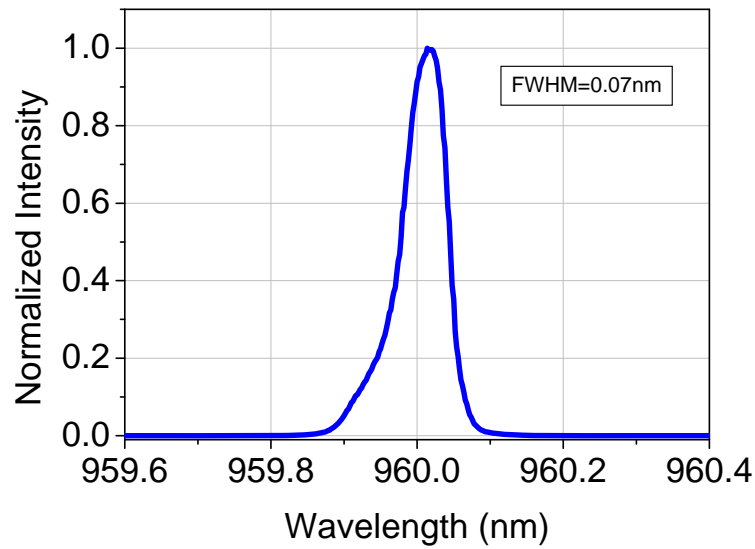

Figure 14. Normalized emission spectrum recorded with 0.002 nm resolution at 15 mW of output power. The Broadsweeper was operated in the Manual Sweep mode (CW operation).

Figures 15-17 illustrate exemplary time traces of the laser output power in the Automatic Sweep mode and Two-Wavelength Modulation mode. The traces were recorded at the booster optical output.

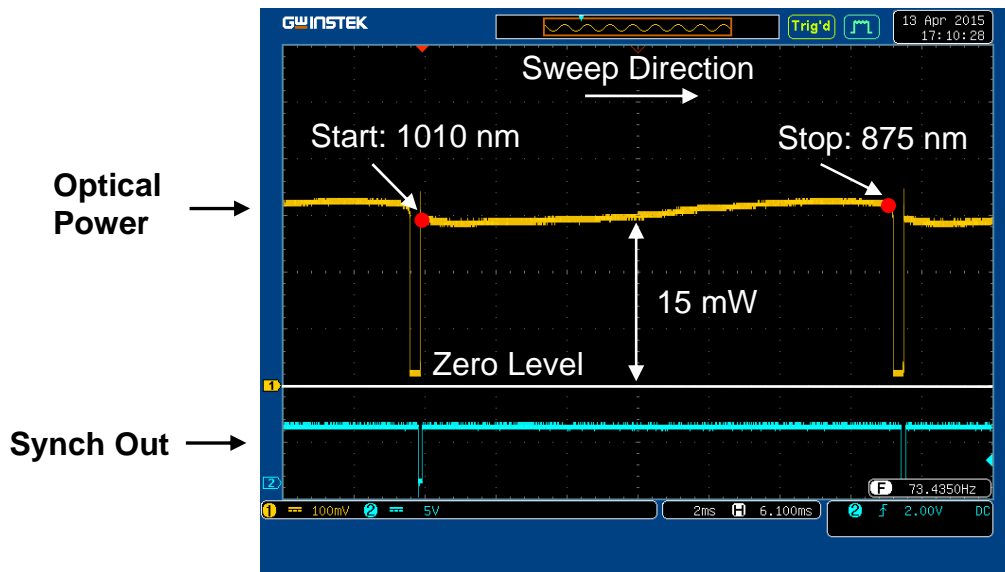

Figure 15. Example of the Broad Sweeper operation in the Automatic Sweep mode. In this mode, the device provides continuous wavelength tuning (from long to short wavelengths) automatically with predefined sweep parameters. For recording this oscillogram, the following sweep parameters have been set: sweep range = 1010-875 nm; output power = 15 mW; sweep speed = 10000 nm/s; sweep time = 13.5 ms. The Broad Sweeper initiates each sweep by an internally generated trigger signal producing TTL-compatible pulses (see "Synch Out") for synchronization needs.

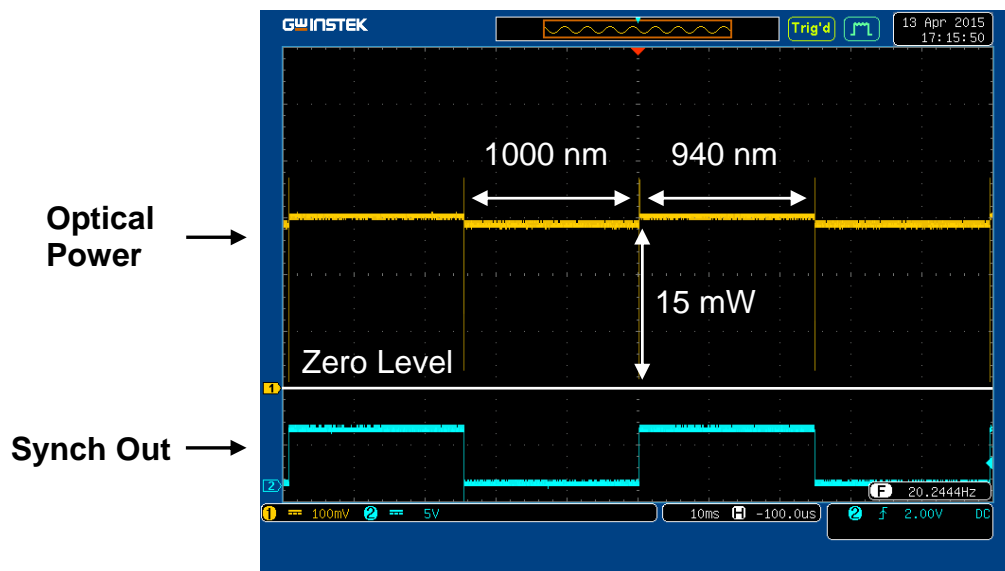

Figure 16. Example of the Broad Sweeper operation in the Two-Wavelength Modulation mode. In this mode of operation, the device continuously switches the emission wavelength between two user-set values at a certain repetition frequency. For recording this oscillogram, the following sweep parameters have been set: wavelength 1 = 1000 nm; wavelength 2 = 940 nm; output power = 15 mW, switching frequency = 20 Hz. The Broad Sweeper produces synchronization pulses available via the Synch Out rear-panel connector. In this mode of operation, the device does not accept external synchronization.

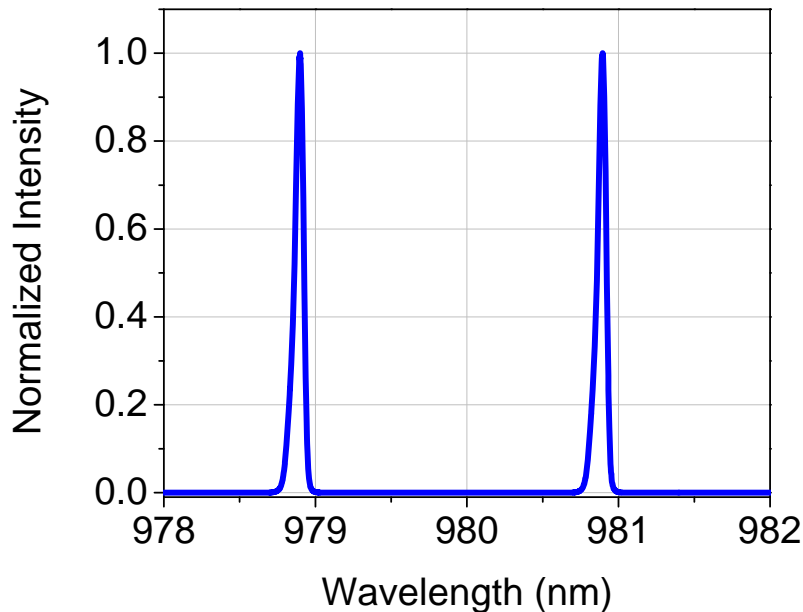

Figure 17. Example of average emission spectrum of the Broadsweeper recorded in the Two-Wavelength Modulation mode by using an optical spectrum analyzer. The following sweep parameters have been used for this record: wavelength 1 = 978.9 nm; wavelength 2 = 980.9 nm; output power = 15 mW, switching frequency = 100 Hz.

6. Summary

We have developed and manufactured the new model of a broadband rapidly tunable laser, the Broadsweeper BS-930-1-HP. The laser is built on the use of a quantum-confined SOA and a quasi-collinear AOTF in an external fiber ring cavity. The device has demonstrated the full tuning range of up to 135 nm at the output power of 15 mW that is the best result ever shown for rapidly swept lasers in 880-1010 nm spectral range. The device can sweep the emission wavelength with a sweep speed from 2 nm/s to 10^4 nm/s. The laser offers the end-user different modes of operation – the manual sweep mode, automatic sweep mode, external sweep mode and two-wavelength switching mode. The model provides high spectral and power stability of laser emission both in time and in temperature. High spectral tuning accuracy and reproducibility together with strictly linear emission frequency sweep in time are ensured. The device is equipped with a PM-fiber output that guarantees high values of PER of laser emission (> 20 dB). Thanks to these advantages of the developed model over the standard BS-930-1, this new swept source can find its place in a variety of applications requiring high-power laser emission together with rapid wavelength tuning over a wide band of wavelengths covering 880-1010 nm. To the best of our knowledge, the new model of the Broadsweeper considerably exceeds the existing analogues.



References

1. Drexler W., Fujimoto J.G., "Optical Coherence Tomography: Technology and Applications" (Berlin, Heidelberg: Springer Publishing, 2008).
2. Drexler W., Liu M., Kumar A., Kamali T., Unterhuber A., Leitgeb R.A. J. Biomed. Opt., 19 (7), 071412 (2014).
3. Fergusson J., "Full Field Swept Source Optical Coherence Tomography", (Cardiff University School of Optometry and Vision Sciences, 2013).
4. Hillmann D., Franke G., Hinkel L., Bonin T., Koch P., and Hüttmann G., Proc. SPIE 8571, 857104 (2013).
5. Hillmann D., Lühns C., Bonin T., Koch P., and Hüttmann G., Opt. Lett. 36, 2390 (2011).
6. Mehta D.S., Anna T., Shakher C., J. Opt. Soc. Korea, 12(3), 341 (2009).
7. Stifter D., Appl. Phys B, 88, 337 (2007).
8. Kawasaki M., "Optical Coherence Tomography" (INTECH, 2003)
9. Andreeva E.V., Magdich L.N, Mamedov D.S., Ruenkov A.A., Shramenko M.V., Yakubovich S.D., Quantum Electron., 36 (4), 324 (2006).
10. Andreeva E.V., Mamedov D.S., Shidlovsky V.R., Shramenko M.V., Yakubovich S.D., Proc. of SPIE, 6079, 275 (2006).
11. Shramenko M.V., Chamorovskiy A.Yu., Hong Chu Liu, Lobintsov A.A., Karnovski K., Wojtkovski M., Yakubovich S.D. Proc. SPIE Int. Soc. Opt. Eng., 9312, 93123B (2015).
12. Application Note on AOTFs, Brimrose Corp. of America (1992).
13. Andreeva E.V., Ilchenko S.N., Ladugin M.A., Marmalyuk A.A., Shramenko M.V., Yakubovich S.D., Quantum Electron., 43(11), 994 (2013).
14. Kostin Yu.O., Ladugin M.A., Lobintsov A.A., Marmalyuk A.A., Chamorovskiy A.Yu., Shramenko M.V., Yakubovich S.D., Quantum Electron., 45(8), 697 (2015).